

PROJECTION

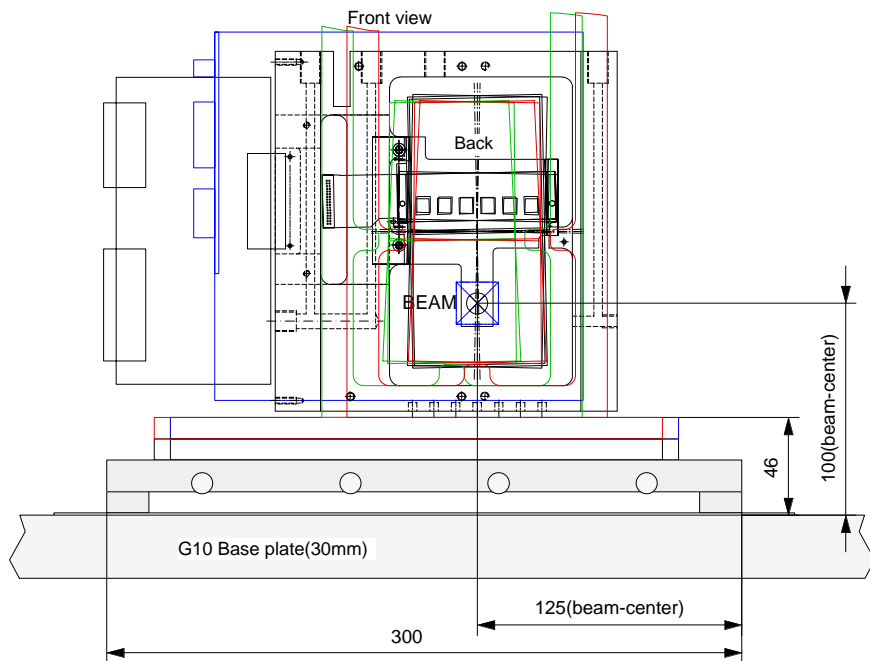
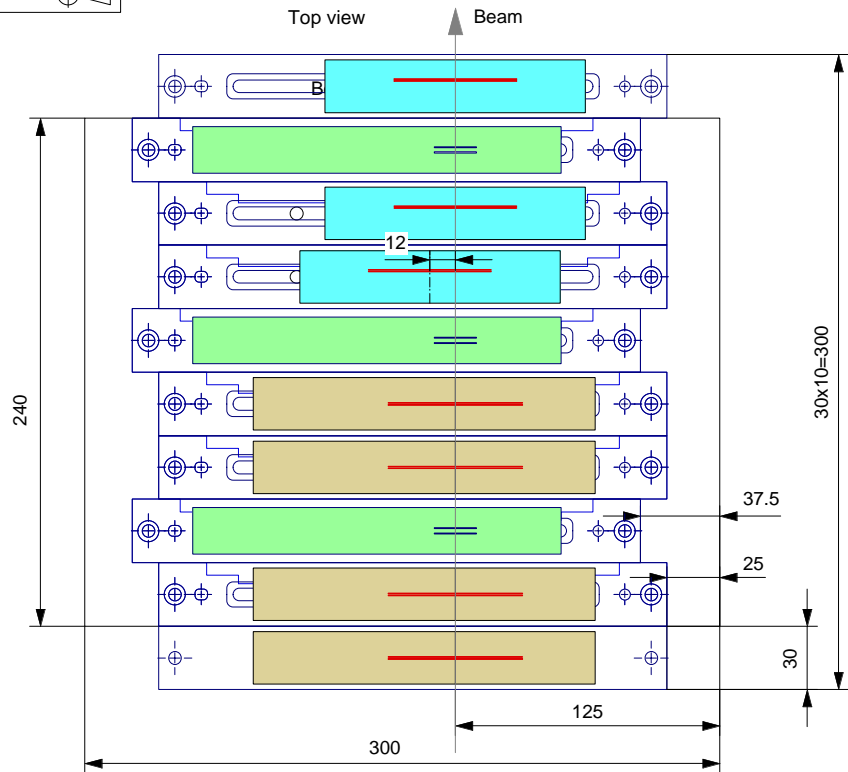

CERN/GNV (ABCD3T)/Freiburg irradi.

Telescope C

Valencia non-irrad (ABCD3T)

Valencia irrad (ABCD3T)

Telescope B

KEK irrad (ABCD3T)

KEK non-irrad (ABCD3Tm Thin&Metalized)

Telescope A

KEK non-irrad (ABCD3T double-decker)

Anchor (k3103)

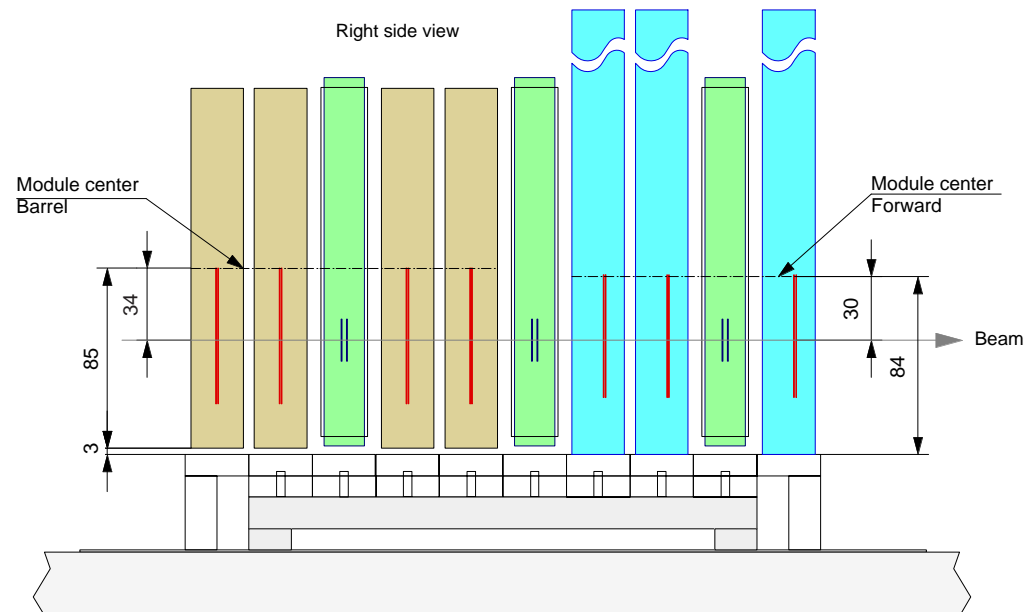
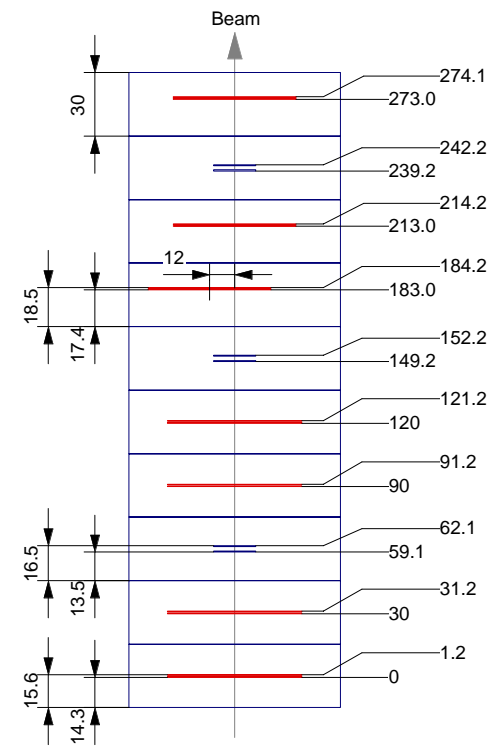

TITLE
FestBeam_KEK200012
Detector layout

DRAWING No.
A3-AT2k1204-2/2

ORIGINAL SCALE
x0.4

2k1208/R0
T.Kohriki@KEK

PROJECTION

- Anchor (k3103@KEK)
- KEK non-irrad (ABCD3T double-decker)
- KEK non-irrad (ABCD3Tm Thin&Metalized)
- KEK irrad (ABCD3T)

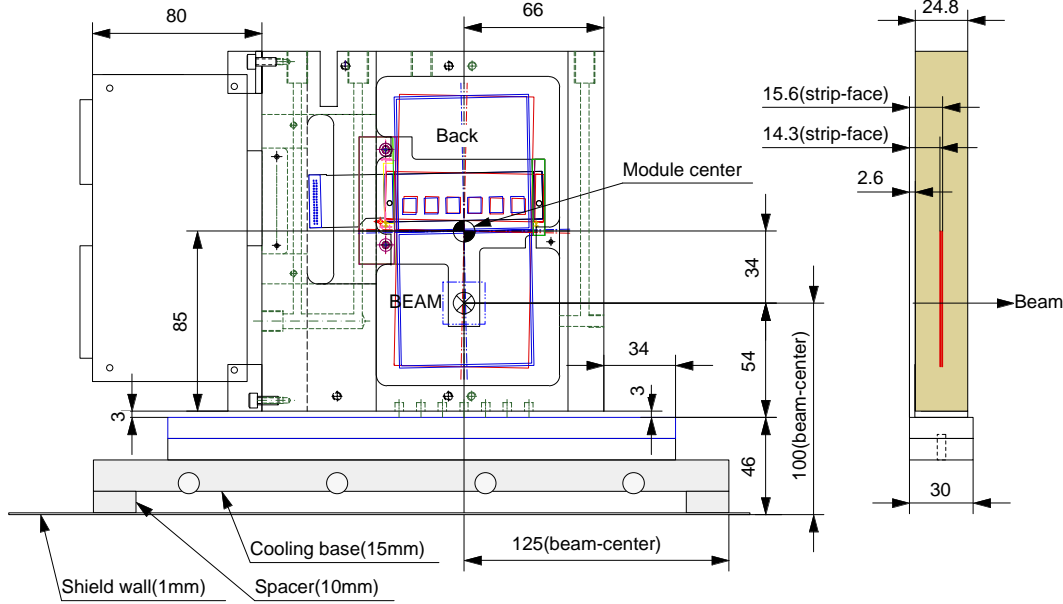

- Valencia non-irrad. (ABCD3T)
- CERN/GNV (ABCD3T)

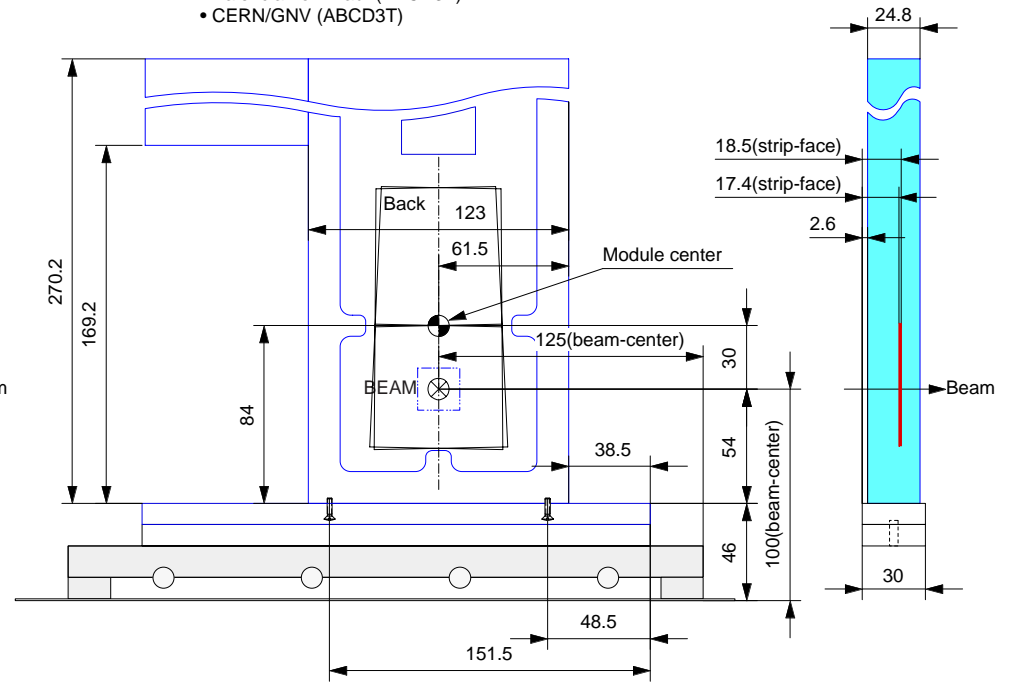

Telescope A,B,C

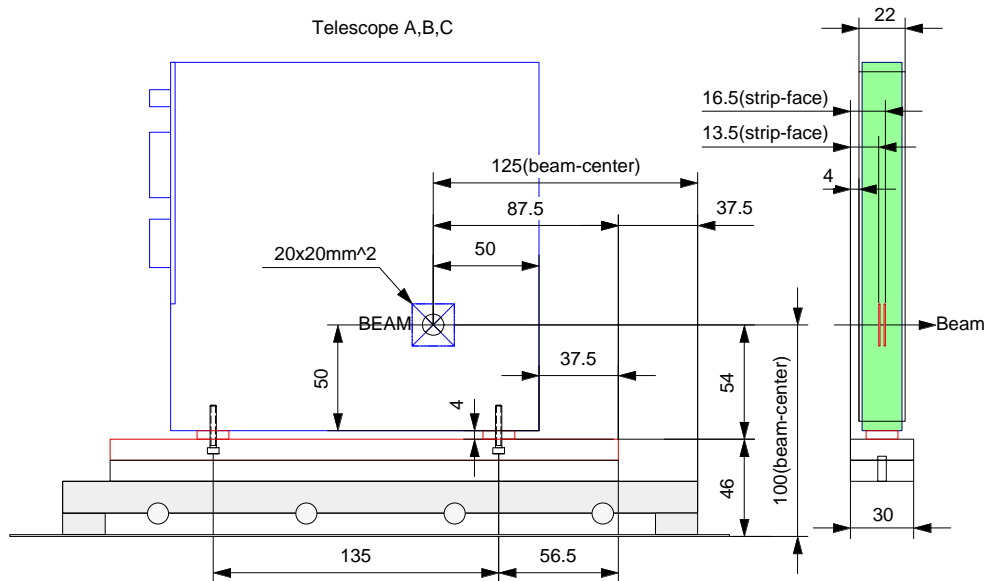

- Valencia irrad. (ABCD3T)

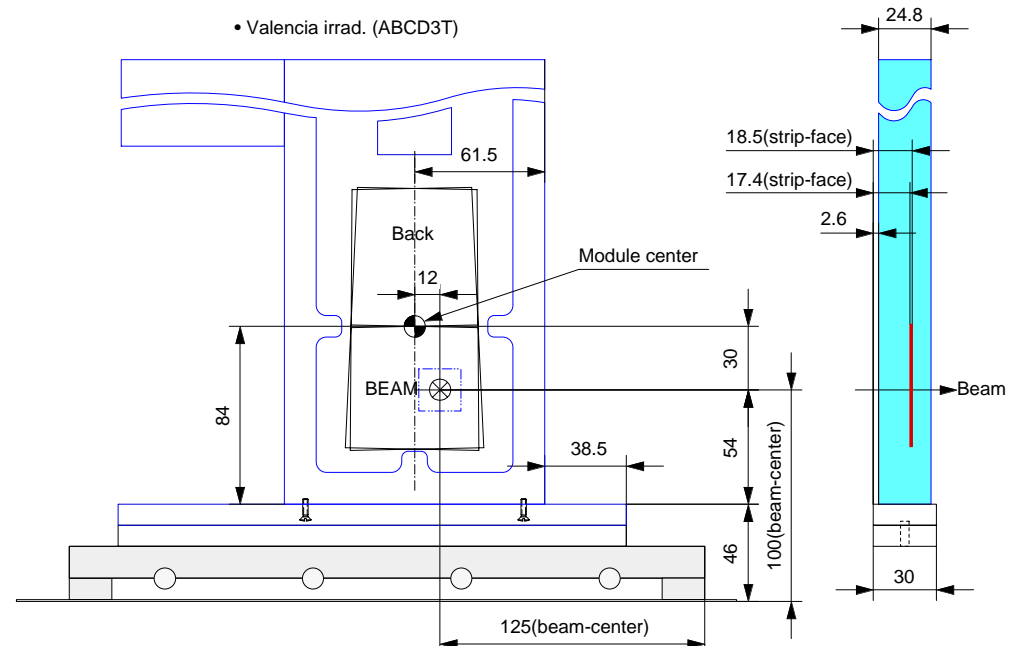

TITLE TestBeam_KEK200012 Modules	DRAWING No. A3-AT2k1204-1/2	ORIGINAL SCALE x0.4	2k1208/R1 T.Kohriki@KEK
--	--------------------------------	------------------------	----------------------------