

**■BASIC CHARACTERISTICS**

1. Zero-power Resistance of Thermistor : R  
 $R=R_0 \exp B (1/T-1/T_0)$  .....(1)  
 R : Resistance in ambient temperature T (K)  
 (K : absolute temperature)  
 R<sub>0</sub> : Resistance in ambient temperature T<sub>0</sub> (K)  
 B : B-constant of Thermistor
2. B-Constant  
 as (1) formula  
 $B= \ell n (R/R_0) / (1/T-1/T_0)$  .....(2)
3. Thermal Dissipation Constant  
 When spend electric power P (mW) in ambient temperature T<sub>1</sub>, if Thermistor's temperature rises T<sub>2</sub>, there is a formula as follows  
 $P=C (T_2-T_1)$  .....(3)  
 C : Thermal dissipation constant (mW/°C)  
 Thermal dissipation constant change by dimensions, measure, measured condition etc.
4. Thermal Time Constant  
 Period in which Thermistor's temperature will change 63.2% of its temperature difference from ambient temperature T<sub>0</sub> (°C) to T<sub>1</sub> (°C).

**■RESISTANCE VS. TEMPERATURE**

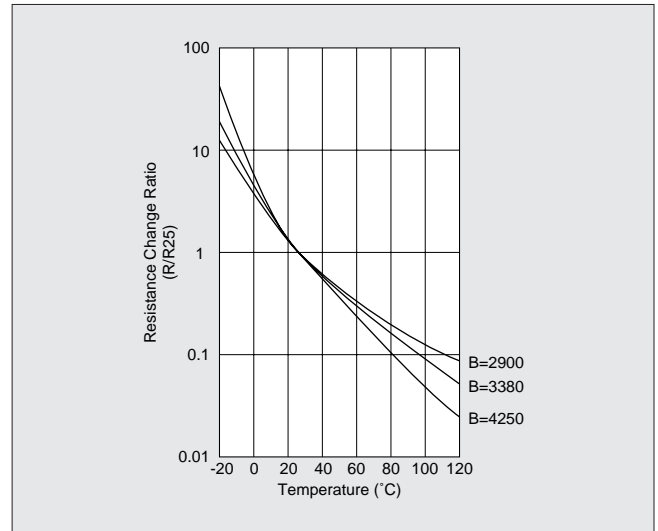

**■THERMAL TIME CONSTANT**

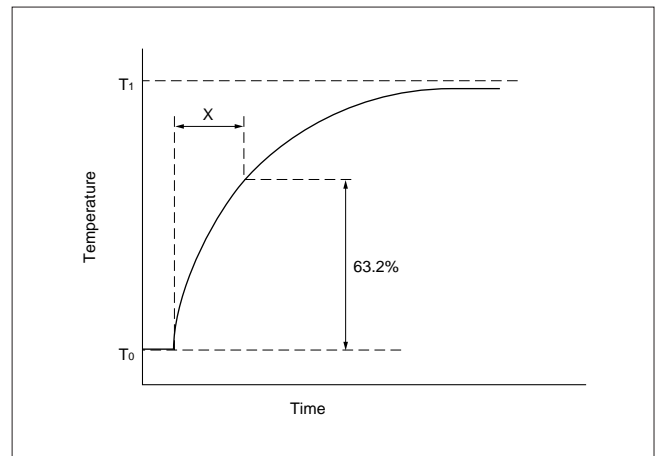

**■PERFORMANCE**

Item	Condition
Resistance	It measures by zero-power in specified ambient temperature.
B-Constant	It calculates between two specified ambient temperature by next formula. T and T <sub>0</sub> is absolute temperature (K). $B = \frac{\ell n (R/R_0)}{1/T-1/T_0}$
Thermal Dissipation Constant	It shows necessary electric power that Thermistor's temperature rises 1°C by self heating. It calculates by next formula. (mW/°C) $C = \frac{P}{T-T_0}$
Rated Electric Power	It shows necessary electric power that Thermistor's temperature rises 100°C by self heating in ambient temperature 25°C.
Permissive Operating Current	It is possible to keep Thermistor's temperature rising max. 1°C

Please inquire about test condition and Ratings.

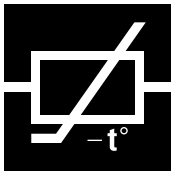

# NTC THERMISTOR



## Chip NTC Thermistor NTH5G10P/16P/20P Series

### Chip NTC Thermistor NTH5G10P/16P/20P Series for Temperature Compensation and Sensing, Suitable for high density mounting in the general circuits.

0402/0603/0805 sized chip NTC thermistor NTH5G10P/16P/20P Series have Ni barrier termination and provide excellent solderability and offer high stability in environment by unique inner construction.

#### FEATURES

1. Excellent solderability and high stability in environment.
2. Excellent long time aging stability.
3. High accuracy in resistance and B-constant.
4. Flow/Reflow soldering possible. (NTH5G16P/20P Series)
5. Same B-constant in the same resistance in the three sizes.  
(0603 size / NTH5G16P Series, 0805 size / NTH5G20P Series, 0402 size / NTH5G10P Series)  
Easy to use smaller size in the circuits.
6. No Pb in the materials. (NTH5G16P/20P Series)

#### APPLICATIONS

- Temperature compensation of transistor, IC, crystal oscillator of mobile communications equipments.
- Temperature sensor for rechargeable batteries.
- Temperature compensation of LCD.
- Temperature compensation and sensing of car audio equipments. (CD, MD, Tuner)
- Temperature compensation of several kinds of circuits.

#### PART NUMBERING

(Please specify the part number when ordering.)



① NTC Thermistor

② Chip Type

③ Size 10 : 1.0x0.5mm  
16 : 1.6x0.8mm  
20 : 2.0x1.25mm

④ Ni Barriered Electrode

⑤ B-Constant (ex. 3500K : 35A, 3950K : 39B)

⑥ Resistance Value (ex. 4.7kΩ : 472, 47kΩ : 473)

⑦ Resistance Tolerance J : ±5%

K : ±10%

⑧ Suffix

⑨ Packaging TH : Paper Tape for 0402/0603 size

TE : Plastic Tape for 0805 size

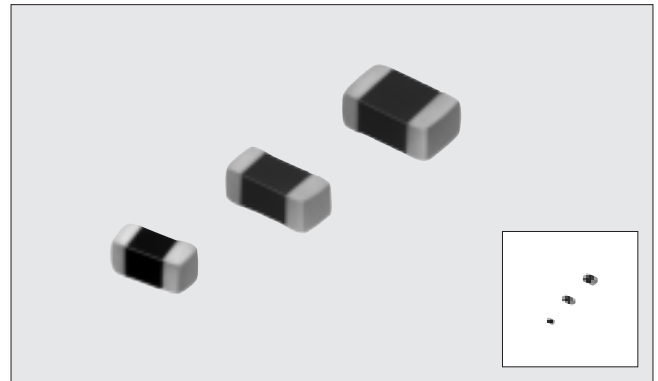

#### DIMENSIONS

Series	Dimensions (mm)			
	L	W	T	e
NTH5G10P	1.0±0.05	0.5±0.05	0.5±0.05	0.15-0.35
NTH5G16P	1.6±0.15	0.8±0.15	0.8±0.15	0.2-0.6
NTH5G20P	2.0±0.2	1.25±0.2	0.85±0.15	0.2-0.7

## ■ RATINGS

### ● NTH5G10P Series

Part Number	Resistance ( $\Omega$ ) 25°C	B-constant (K) 25/50°C	Permissible Operating Current (mA) (Note 1, Note 2)	Rated Electric Power (mW) (Note 1, Note 3)	Thermal Dissipation Constant (mW/°C) (Note 1)
NTH5G10P35A221□08TH	220	3500±3%	2.10	100	1.0
NTH5G10P35A331□08TH	330	3500±3%	1.70		
NTH5G10P36B471□08TH	470	3650±3%	1.40		
NTH5G10P36B681□08TH	680	3650±3%	1.20		
NTH5G10P36B102□08TH	1.0k	3650±3%	1.00		
NTH5G10P39B152□08TH	1.5k	3950±3%	0.81		
NTH5G10P39B222□08TH	2.2k	3950±3%	0.67		
NTH5G10P39B332□08TH	3.3k	3950±3%	0.55		
NTH5G10P39B472□08TH	4.7k	3950±3%	0.46		
NTH5G10P39B682□08TH	6.8k	3950±3%	0.38		
NTH5G10P33B103□08TH	10k	3380±3%	0.31		
NTH5G10P39B153□08TH	15k	3950±3%	0.25		
NTH5G10P39B223□08TH	22k	3950±3%	0.21		
NTH5G10P40B333□08TH	33k	4050±3%	0.17		
NTH5G10P40B473□08TH	47k	4050±3%	0.14		
NTH5G10P41B683□08TH	68k	4150±3%	0.12		
NTH5G10P42B104□08TH	100k	4250±3%	0.10		
NTH5G10P45A224□08TH	220k	4500±3%	0.06		
NTH5G10P45A474□08TH	470k	4500±3%	0.04		

### ● NTH5G16P Series

Part Number	Resistance ( $\Omega$ ) 25°C	B-constant (K) 25/50°C	Permissible Operating Current (mA) (Note 1, Note 2)	Rated Electric Power (mW) (Note 1, Note 3)	Thermal Dissipation Constant (mW/°C) (Note 1)
NTH5G16P35A221□07TH	220	3500±3%	2.10	100	1.0
NTH5G16P35A331□07TH	330	3500±3%	1.70		
NTH5G16P36B471□07TH	470	3650±3%	1.40		
NTH5G16P36B681□07TH	680	3650±3%	1.20		
NTH5G16P36B102□07TH	1.0k	3650±3%	1.00		
NTH5G16P39B152□07TH	1.5k	3950±3%	0.81		
NTH5G16P39B222□07TH	2.2k	3950±3%	0.67		
NTH5G16P39B332□07TH	3.3k	3950±3%	0.55		
NTH5G16P39B472□07TH	4.7k	3950±3%	0.46		
NTH5G16P39B682□07TH	6.8k	3950±3%	0.38		
NTH5G16P33B103□07TH	10k	3380±3%	0.31		
NTH5G16P39B153□07TH	15k	3950±3%	0.25		
NTH5G16P39B223□07TH	22k	3950±3%	0.21		
NTH5G16P40B333□07TH	33k	4050±3%	0.17		
NTH5G16P40B473□07TH	47k	4050±3%	0.14		
NTH5G16P41B683□07TH	68k	4150±3%	0.12		
NTH5G16P42B104□07TH	100k	4250±3%	0.10		
NTH5G16P45A224□07TH	220k	4500±3%	0.06		
NTH5G16P45A474□07TH	470k	4500±3%	0.04		

● NTH5G20P Series

Part Number	Resistance (Ω) 25°C	B-constant (K) 25/50°C	Permissive Operating Current (mA) (Note 1, Note 2)	Rated Electric Power (mW) (Note 1, Note 3)	Thermal Dissipation Constant (mW/°C) (Note 1)
NTH5G20P35A221□07TE	220	3500±3%	3.00	200	2.0
NTH5G20P36B471□07TE	470	3650±3%	2.00		
NTH5G20P36B102□07TE	1.0k	3650±3%	1.40		
NTH5G20P39B222□07TE	2.2k	3950±3%	0.90		
NTH5G20P39B472□07TE	4.7k	3950±3%	0.65		
NTH5G20P39A103□07TE	10k	3900±3%	0.44		
NTH5G20P39B153□07TE	15k	3950±3%	0.36		
NTH5G20P39B223□07TE	22k	3950±3%	0.30		
NTH5G20P40B333□07TE	33k	4050±3%	0.24		
NTH5G20P40B473□07TE	47k	4050±3%	0.20		
NTH5G20P42B104□07TE	100k	4250±3%	0.14		

● NTH5G Tight Tolerance type

Part Number	Resistance (Ω) 25°C	B-constant (K)		Permissive Operating Current (mA) (Note 1, Note 2)	Rated Electric Power (mW) (Note 1, Note 3)	Thermal Dissipation Constant (mW/°C) (Note 1)
		25/50°C	25/85°C (reference value)			
NTH5G10P33B103F08TH	10k±1%	3380±1%	3435	0.31	100	1.0
NTH5G16P33B103F07TH	10k±1%	3380±1%	3435	0.31	100	1.0

- : Resistance Tolerance (J : ±5%, K : ±10%)
- Operating Temperature Range : -40 to +125°C

(Note 1) When measured at 25°C in still air, as a single unit without mounting.

(Note 2) Permissive Operating Current raises Thermistor's temperature by 1°C. The current less than 1/10 of the Permissive Operating Current value is recommended in order to prevent self heating of the NTC Thermistor.

(Note 3) NTC Thermistor's temperature rises by approx. 100°C at 25°C in still air when Rated Electric Power is applied. Too rapid temperature rising, however, may cause any unexpected failures on your circuit. Please do not apply higher than 10mW (NTH5G10P/16P) or 20mW (NTH5G20P) of electric power in shot time. (10mW or 20mW of power gives NTC Thermistor approx. 10°C of temperature rising.) The electric power related with operating temperature is shown in the graph right.

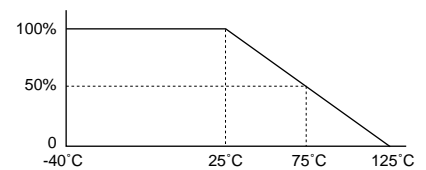

**■ DIMENSIONS OF TAPE**

**NTH5G10P Series (Paper Tape)**

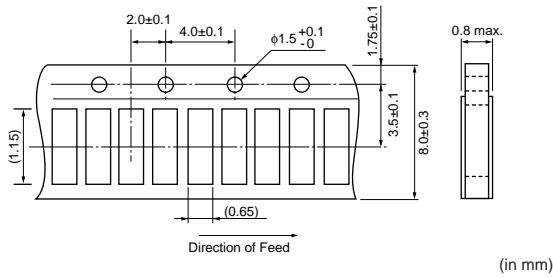

**NTH5G16P Series (Paper Tape)**

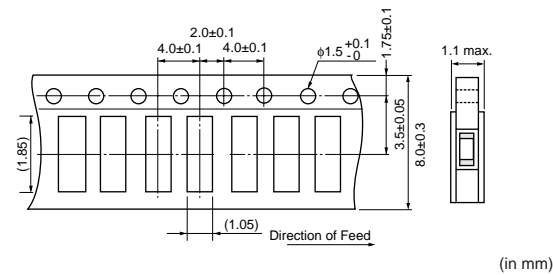

**NTH5G20P Series (Plastic Tape)**

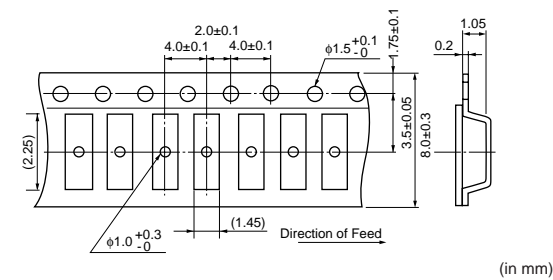

**■ DIMENSIONS OF REEL**

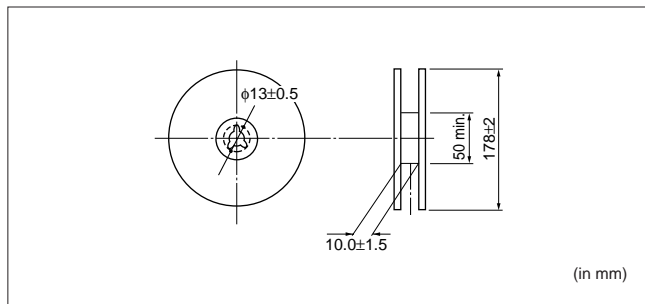

**■ MINIMUM QUANTITY (order in sets only)**

- NTH5G10P Series : 10,000pcs.
- NTH5G16P/20P Series : 4,000pcs.

**■ STANDARD LAND PATTERN**

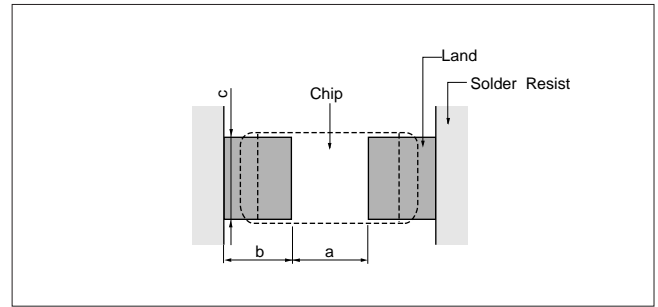

**Reflow Soldering**

Series	a	b	c
NTH5G10P	0.4	0.4 – 0.5	0.5
NTH5G16P	0.6 – 0.8	0.6 – 0.7	0.6 – 0.8
NTH5G20P	1.0 – 1.1	0.6 – 0.7	1.0 – 1.2

**Flow Soldering**

Series	a	b	c
NTH5G16P	0.6 – 1.0	0.8 – 0.9	0.6 – 0.8
NTH5G20P	1.0 – 1.1	0.9 – 1.0	1.0 – 1.2

**■ SOLDERING TEMPERATURE AND TIME**

- Solder within the temperature and time combinations, indicated by the slanted lines in the following graph.
- In the case that soldering is repeated more than twice, the allowable reflow soldering time should be the accumulated soldering time.

Allowable Reflow Soldering Temperature and Time

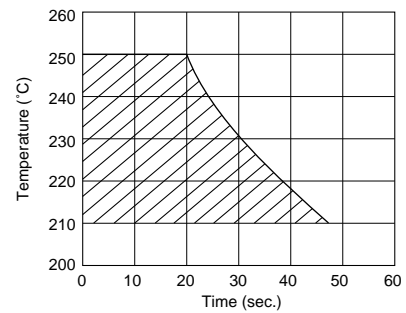

Allowable Flow Soldering Temperature and Time

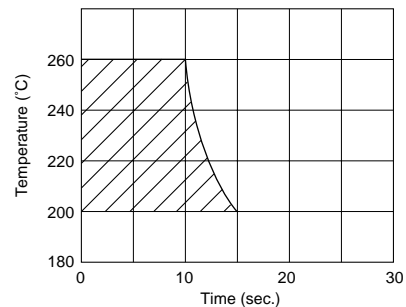

**STANDARD SOLDERING CONDITIONS**

- Insufficient preheating may cause a crack on ceramic body.
- Rapid cooling by dipping in solvent or by other means is not recommended.

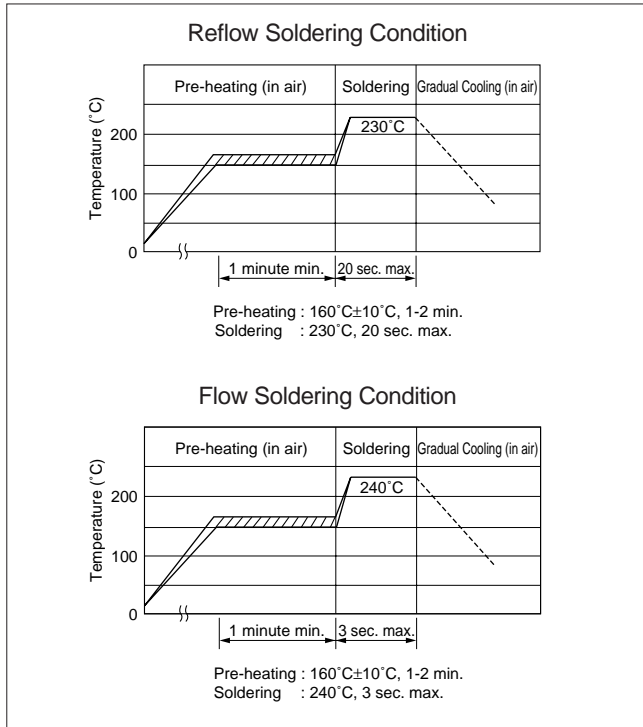

- ⑦ Place strongly vibrated
  - ⑧ Other place, where is similar like the above-mentioned environments
3. Be sure to provide an appropriate fail-safe function on your product to prevent a second damage that may be caused by the abnormal function or the failure of our product.

**NOTICE**

1. Use this product within the specified temperature range. Higher temperature may cause deterioration of the characteristics or the material quality of this products.
2. Following conditions should be kept in order to avoid deterioration of solderability of external electrodes and the characteristics of this products.
  - ① Storage condition Temperature : -10 to +40°C Humidity : less than 75%RH
  - ② Storage term Use this product within 6 months after delivery
  - ③ Handling after unpacking After unpacking, reseal promptly this product or store it in a sealed container with a drying agent.
  - ④ Storage place Store this product in no corrosive gas (SO<sub>x</sub>, Cl etc.) nor directly under sunshine.
3. Do not give this product a strong press-force nor a mechanical shock. Because such mechanical forces may cause cracking or chipping of this ceramic product.
4. Location on Printed Circuit Board (PC Board)

<Component Direction>

Locate this product horizontal to the direction in which stress acts.

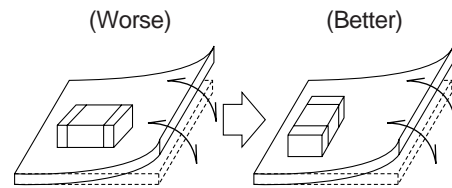

(Mounting Close to Board Separation Line)

Keep this product on the PC Board away from the Separation Line. Worst ← A-B-C-D → Better

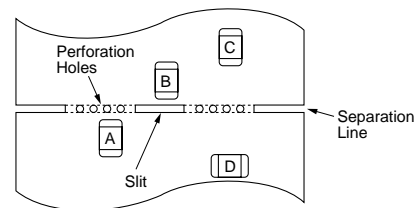

**CLEANING CONDITIONS**

1. When cleaning for removing flux is applied, pay attention as follows to avoid the decline of element characteristic or the deteriorate electrode material.

Solvent	Dipping Cleaning	Ultrasonic Cleaning
Isopropyl Alcohol	Less than 5 min. at room temperature or Less than 2 min. 40°C max.	Less than 1 min. 20W/ℓ Frequency of several 10kHz to several 100kHz

2. A sufficient cleaning shall be applied to remove flux completely.
3. After cleaning, dry this product promptly.
4. Please contact us before using other solvents.

**CAUTION**

1. Applying the power exceeding the specified 'Rated Electric Power' may causes deterioration of the characteristics or destruction of this product. Do not apply the power exceeding the 'Rated Electric Power'.
2. This product is designed for the applications under ordinary environment (room temperature, normal humidity and atmospheric pressure). Do not use under the following environments. Because all these factors can deteriorate the characteristics of product or can cause the failures and the burning-out.
  - ① Corrosive gas or deoxidizing gas. (Cl<sub>2</sub>, H<sub>2</sub>S, NH<sub>3</sub>, SO<sub>x</sub>, NO<sub>x</sub>, etc.)
  - ② Volatile or flammable gas
  - ③ Dusty place
  - ④ Under vacuum, reducing pressure or under high-pressure
  - ⑤ Place with splashed water or under high humidity with dewing
  - ⑥ Place with salt water, oils, chemical liquids or organic solvents

■TEMPERATURE CHARACTERISTICS (reference value)

Temp. (°C)	NTH5G**P35A221J type			NTH5G**P35A331J type			NTH5G**P36B471J type			NTH5G**P36B681J type			NTH5G**P36B102J type		
	Resistance (Ω)			Resistance (Ω)			Resistance (Ω)			Resistance (Ω)			Resistance (kΩ)		
	Low	Center	High	Low	Center	High	Low	Center	High	Low	Center	High	Low	Center	High
-40	4281.3910	4947.9037	5703.8815	6422.0865	7421.8556	8555.8223	10195.6193	11822.4726	13674.6409	14751.1087	17104.8540	19784.5868	21.6928	25.1542	29.0950
-35	3232.8028	3703.7546	4232.7058	4849.2043	5555.6318	6349.0587	7629.3548	8767.7450	10050.8064	11038.2154	12685.2480	14541.5923	16.2327	18.6548	21.3847
-30	2463.5987	2798.8729	3171.8255	3695.3981	4198.3094	4757.7383	5766.8583	6570.2235	7466.7895	8343.5396	9505.8552	10803.0146	12.2699	13.9792	15.8868
-25	1895.3406	2135.8872	2400.9454	2843.0109	3203.8309	3601.4182	4400.5140	4971.7838	5603.1722	6366.7012	7193.2191	8106.7172	9.3628	10.5783	11.9216
-20	1471.2503	1645.0366	1834.7523	2206.8755	2467.5549	2752.1285	3387.9463	3796.9333	4244.6543	4901.7096	5493.4355	6141.2019	7.2084	8.0786	9.0312
-15	1151.7079	1278.0338	1414.6703	1727.5619	1917.0507	2122.0054	2629.0453	2923.3995	3242.5836	3803.7251	4229.5993	4691.3975	5.5937	6.2200	6.8991
-10	908.3588	1000.6201	1099.4967	1362.5382	1500.9302	1649.2450	2056.6347	2269.5988	2498.3537	2975.5566	3283.6749	3614.6394	4.3758	4.8289	5.3156
-5	721.9176	789.6120	861.4951	1082.8764	1184.4181	1292.2426	1620.5498	1775.2252	1939.8021	2344.6253	2568.4109	2806.5222	3.4480	3.7771	4.1272
0	577.8973	627.7522	680.2030	866.8464	941.6283	1020.3045	1286.3077	1399.0503	1517.8704	1861.0410	2024.1579	2196.0679	2.7368	2.9767	3.2295
5	465.6678	502.4737	540.8332	698.5017	753.7106	811.2498	1027.8581	1110.2196	1196.1827	1487.1139	1606.2752	1730.6473	2.1869	2.3622	2.5451
10	377.7788	405.0095	433.1175	566.6681	607.5142	649.6763	826.9792	887.2572	949.5490	1196.4806	1283.6913	1373.8156	1.7595	1.8878	2.0203
15	308.3256	328.4797	349.0764	462.4884	492.7196	523.6146	669.3557	713.4632	758.5760	968.4295	1032.2446	1097.5142	1.4242	1.5180	1.6140
20	253.1370	268.0437	283.1186	379.7056	402.0655	424.6779	545.1310	577.3752	609.9977	788.7002	835.3513	882.5499	1.1599	1.2285	1.2979
25	209.0000	220.0000	231.0000	313.5000	330.0000	346.5000	446.5000	470.0000	493.5000	646.0000	680.0000	714.0000	0.9500	1.0000	1.0500
30	171.5071	181.5764	191.7562	257.2606	272.3645	287.6344	363.3735	384.8004	406.4270	525.7319	556.7325	588.0872	0.7731	0.8187	0.8648
35	141.5184	150.6681	160.0084	212.2777	226.0022	240.0126	297.3779	316.7570	336.5555	430.2488	458.2867	486.9313	0.6327	0.6740	0.7161
40	117.4077	125.6805	134.1997	176.1116	188.5207	201.2996	244.7447	262.1771	280.1490	354.0986	379.3200	405.3220	0.5207	0.5578	0.5961
45	97.8822	105.3357	113.0734	146.8233	158.0036	169.6100	202.4473	218.0688	234.3085	292.9025	315.5038	338.9995	0.4307	0.4640	0.4985
50	82.0161	88.7172	95.7259	123.0241	133.0758	143.5889	168.3307	182.2969	196.9284	243.5424	263.7488	284.9176	0.3582	0.3879	0.4190
55	69.0420	75.0585	81.3954	103.5629	112.5878	122.0932	140.6799	153.1503	166.3093	203.5369	221.5791	240.6177	0.2993	0.3259	0.3538
60	58.3788	63.7771	69.5003	87.5683	95.6656	104.2504	118.1215	129.2486	141.0702	170.8993	186.9979	204.1015	0.2513	0.2750	0.3001
65	49.5725	54.4149	59.5811	74.3587	81.6224	89.3717	99.6242	109.5508	120.1654	144.1371	158.4991	173.8563	0.2120	0.2331	0.2557
70	42.2849	46.6309	51.2951	63.4274	69.9464	76.9427	84.4206	93.2811	102.8140	122.1404	134.9600	148.7522	0.1796	0.1985	0.2188
75	36.2121	40.1147	44.3268	54.3182	60.1721	66.4903	71.8361	79.7499	88.3142	103.9331	115.3828	127.7737	0.1528	0.1697	0.1879
80	31.1296	34.6367	38.4425	46.6944	51.9550	57.6638	61.3721	68.4463	76.1450	88.7937	99.0287	110.1673	0.1306	0.1456	0.1620
85	26.8580	30.0126	33.4539	40.2870	45.0189	50.1808	52.6633	58.9961	65.9251	76.1938	85.3560	95.8700	0.1120	0.1255	0.1403
90	23.2681	26.1099	29.2256	34.9021	39.1649	43.8384	45.3599	51.0359	57.2785	65.6271	73.8391	82.8710	0.0965	0.1086	0.1219
95	20.2272	22.7904	25.6142	30.3407	34.1856	38.4213	39.2354	44.3318	49.9651	56.7661	64.1397	72.2899	0.0835	0.0943	0.1063
100	17.6416	19.9565	22.5187	26.4624	29.9347	33.7781	34.0575	38.6403	43.7302	49.2747	55.9052	63.2693	0.0725	0.0822	0.0930
105	15.4465	17.5411	19.8700	23.1698	26.3117	29.8050	29.6631	33.7903	38.3956	42.9169	48.8881	55.5510	0.0631	0.0719	0.0817
110	13.5562	15.4531	17.5715	20.3343	23.1797	23.3572	25.9394	29.6642	33.8390	37.5294	42.9184	48.9586	0.0552	0.0631	0.0720
115	11.9416	13.6629	15.5934	17.9123	20.4944	23.3900	22.7557	26.1228	29.9131	32.9232	37.7947	43.2785	0.0484	0.0556	0.0636
120	10.5495	12.1139	13.8754	15.8243	18.1708	20.8131	20.0407	23.0913	26.5397	28.9950	33.4086	38.3979	0.0426	0.0491	0.0565
125	9.3537	10.7784	12.3891	14.0305	16.1676	18.5837	17.7029	20.4715	23.6139	25.6127	29.6183	34.1648	0.0377	0.0436	0.0502

Temp. (°C)	NTH5G**P39B152J type			NTH5G**P39B222J type			NTH5G**P39B332J type			NTH5G**P39B472J type			NTH5G**P39B682J type		
	Resistance (kΩ)			Resistance (kΩ)			Resistance (kΩ)			Resistance (kΩ)			Resistance (kΩ)		
	Low	Center	High	Low	Center	High	Low	Center	High	Low	Center	High	Low	Center	High
-40	44.2420	51.7912	60.4770	64.8883	75.9605	88.6996	97.3324	113.9407	133.0495	138.6250	162.2792	189.4947	200.5638	234.7869	274.1625
-35	32.0716	37.1724	42.9768	47.0383	54.5195	63.0326	70.5575	81.7793	94.5489	100.4910	116.4736	134.6606	145.3912	168.5150	194.8281
-30	23.5236	27.0048	30.9236	34.5013	39.6070	45.3547	51.7519	59.4105	68.0320	73.7073	84.6150	96.8941	106.6403	122.4217	140.1871
-25	17.4452	19.8426	22.5130	25.5863	29.1025	33.0190	38.3795	43.6537	49.2585	54.6617	62.1734	70.5406	79.0850	89.9531	102.0588
-20	13.0647	14.7278	16.5611	19.1616	21.6008	24.2896	28.7424	32.4012	36.4344	40.9361	46.1471	51.8914	59.2268	66.7661	75.0769
-15	9.8817	11.0439	12.3118	14.4932	16.1977	18.0573	21.7398	24.2965	27.0859	30.9628	34.6041	38.5769	44.7972	50.0655	55.8134
-10	7.5445	8.3617	9.2442	11.0653	12.2638	13.5581	16.5979	18.3956	20.3372	23.6394	26.1999	28.9651	34.2017	37.9062	41.9069
-5	5.8112	6.3888	7.0063	8.5230	9.3702	10.2759	12.7846	14.0554	15.4138	18.2083	20.0182	21.9531	26.3439	28.9626	31.7619
0	4.5122	4.9221	5.3557	6.6179	7.2190	7.8551	9.9269	10.8286	11.7826	14.1383	15.4225	16.7813	20.4554	22.3134	24.2794
5	3.5327	3.8245	4.1301	5.1813	5.6093	6.0575	7.7719	8.4140	9.0863	11.0691	11.9835	12.9410	16.0149	17.3379	18.7232
10	2.7856	2.9936	3.2092	4.0856	4.3907	4.7068	6.1283	6.5860	7.0602	8.7282	9.3801	10.0554	12.6281	13.5712	14.5482
15	2.2129	2.3613	2.5134	3.2456	3.4633	3.6863	4.8684	5.1949	5.5294	6.9338	7.3988	7.8752	10.0319	10.7046	11.3939
20	1.7699	1.8756	1.9826	2.5959	2.7509	2.9079	3.8938	4.1263	4.3618	5.5458	5.8769	6.2123	8.0237	8.5028	8.9880
25	1.4250	1.5000	1.5750	2.0900	2.2000	2.3100	3.1350	3.3000	3.4650	4.4650	4.7000	4.9350	6.4600	6.8000	7.1400
30	1.1396	1.2074	1.2760	1.6714	1.7709	1.8715	2.5071	2.6563	2.8073	3.5707	3.7832	3.9983	5.1661	5.4735	5.7848
35	0.9172	0.9780	1.0401	1.3453	1.4344	1.5256	2.0179	2.1516	2.2883	2.8740	3.0644	3.2591	4.1582	4.4335	4.7153
40	0.7428	0.7969	0.8528	1.0895	1.1688	1.2507	1.6342	1.7532	1.8761	2.3275	2.4970	2.6720	3.3675	3.6126	3.8659
45	0.6051	0.6531	0.7030	0.8875	0.9578	1.0311	1.3313	1.4367	1.5467	1.8960	2.0462	2.2028	2.7432	2.9605	3.1871
50	0.4958	0.5382	0.5828	0.7272	0.7894	0.8548	1.0908	1.1841	1.2821	1.5536	1.6864	1.8261	2.2478	2.4400	2.6420
55	0.4085	0.4459	0.4856	0.5991	0.6540	0.7122	0.8987	0.9811	1.0683	1.2800	1.3973	1.5215	1.8518	2.0216	2.2013
60	0.3383	0.3713	0.4066	0.4962	0.5446	0.5963	0.7442	0.8169	0.8945	1.0600	1.1635	1.2739	1.5336	1.6834	1.8431
65	0.2817	0.3108	0.3421	0.4131	0.4559	0.5018	0.6197	0.6838	0.7527	0.8825	0.9739	1.0720	1.2769	1.4091	1.5511
70	0.2355	0.2613	0.2891	0.3455	0.3832	0.4240	0.5182	0.5748	0.6360	0.7380	0.8187	0.9059	1.0678	1.1845	1.3106
75	0.1981	0.2208	0.2456	0.2905	0.3229	0.3602	0.4357	0.4858	0.5403	0.6206	0.6919	0.7695	0.8979	1.0010	1.1133
80	0.1672	0.1873	0.2094	0.2452	0.2748	0.3071	0.3679	0.4122	0.4606	0.5239	0.5870	0.6561	0.7580	0.8493	0.9492
85	0.1418	0.1597	0.1793	0.2080	0.2342	0.2630	0.3121	0.3513	0.3945	0.44					

Temp. (°C)	NTH5G**P33B103J type			NTH5G**P39B153J type			NTH5G**P39B223J type			NTH5G**P40B333J type			NTH5G**P40B473J type		
	Resistance (kΩ)			Resistance (kΩ)			Resistance (kΩ)			Resistance (kΩ)			Resistance (kΩ)		
	Low	Center	High	Low	Center	High	Low	Center	High	Low	Center	High	Low	Center	High
-40	170.0056	195.6520	224.6043	442.4201	517.9122	604.7702	648.8828	759.6046	886.9963	1046.0404	1227.2628	1436.2815	1489.8151	1747.9197	2045.6131
-35	129.8266	148.1710	168.6845	320.7159	371.7242	429.7679	470.3834	545.1955	630.3263	752.9420	874.4491	1013.0257	1072.3720	1245.4275	1442.7942
-30	100.1156	113.3471	128.0065	235.2360	270.0479	309.2363	345.0129	396.0702	453.5466	548.5400	630.8514	723.7003	781.2539	898.4853	1030.7247
-25	77.9389	87.5588	98.1201	174.4523	198.4259	225.1297	255.8634	291.0246	330.1902	404.1776	460.4568	523.2611	575.6469	655.8022	745.2507
-20	61.1957	68.2367	75.8975	130.6473	147.2781	165.6109	191.6160	216.0079	242.8960	300.9970	339.7972	382.6399	428.6928	483.9536	544.9720
-15	48.4622	53.6496	59.2437	98.8174	110.4385	123.1178	144.9322	161.9765	180.5728	226.4171	253.3626	282.8061	322.4729	360.8498	402.7844
-10	38.6653	42.5062	46.6117	75.4449	83.6166	92.4417	110.6525	122.6377	135.5811	171.9353	190.7661	211.1301	244.8776	271.6971	300.7004
-5	31.0399	33.8922	36.9140	58.1116	63.8880	70.0629	85.2304	93.7024	102.7590	131.7346	144.9635	159.1220	187.6220	206.4631	226.6283
0	25.0925	27.2186	29.4511	45.1222	49.2208	53.5574	66.1792	72.1905	78.5508	101.7587	111.0867	120.9667	144.9290	158.2144	172.2859
5	20.4304	22.0211	23.6762	35.3270	38.2453	41.3011	51.8130	56.0931	60.5750	79.2440	85.8417	92.7563	112.8627	122.2594	132.1074
10	16.7337	17.9255	19.1542	27.8561	29.9364	32.0916	40.8555	43.9067	47.0677	62.1868	66.8613	71.7074	88.5691	95.2267	102.1287
15	13.7804	14.6735	15.5855	22.1292	23.6131	25.1336	32.4561	34.6325	36.8626	49.1580	52.4701	55.8655	70.0128	74.7302	79.5660
20	11.4116	12.0805	12.7567	17.6993	18.7561	19.8264	25.9589	27.5090	29.0787	39.1283	41.4709	43.8440	55.7281	59.0647	62.4445
25	9.5000	10.0000	10.5000	14.2500	15.0000	15.7500	20.9000	22.0000	23.1000	31.3500	33.0000	34.6500	44.6500	47.0000	49.3500
30	7.8552	8.3145	8.7787	11.3959	12.0740	12.7605	16.7139	17.7085	18.7154	24.9421	26.4303	27.9372	35.5236	37.6431	39.7894
35	6.5288	6.9479	7.3754	9.1724	9.7799	10.4015	13.4529	14.3438	15.2555	19.9693	21.2983	22.6589	28.4412	30.3339	32.2718
40	5.4531	5.8336	6.2252	7.4283	7.9691	8.5278	10.8949	11.6880	12.5074	16.0869	17.2658	18.4849	22.9116	24.5907	26.3270
45	4.5726	4.9169	5.2739	6.0512	6.5306	7.0303	8.8751	9.5782	10.3111	13.0349	14.0761	15.1626	18.5648	20.0478	21.5952
50	3.8502	4.1609	4.4854	4.9583	5.3823	5.8279	7.2722	7.8940	8.5475	10.6207	11.5377	12.5026	15.1264	16.4325	17.8067
55	3.2551	3.5350	3.8293	4.0850	4.4593	4.8558	5.9913	6.5403	7.1219	8.6995	9.5058	10.3608	12.3902	13.5385	14.7563
60	2.7624	3.0143	3.2809	3.3829	3.7133	4.0657	4.9616	5.4462	5.9631	7.1620	7.8702	8.6269	10.2005	11.2091	12.2868
65	2.3591	2.5861	2.8279	2.8166	3.1082	3.4214	4.1310	4.5587	5.0181	5.9272	6.5494	7.2187	8.4418	9.3279	10.2811
70	2.0230	2.2275	2.4467	2.3554	2.6128	2.8911	3.4546	3.8321	4.2403	4.9285	5.4751	6.0672	7.0194	7.7979	8.6411
75	1.7401	1.9245	2.1232	1.9806	2.2082	2.4558	2.9049	3.2387	3.6018	4.1145	4.5950	5.1187	5.8601	6.5443	7.2902
80	1.5022	1.6685	1.8486	1.6721	1.8734	2.0938	2.4524	2.7477	3.0709	3.4514	3.8742	4.3379	4.9156	5.5178	6.1782
85	1.3019	1.4521	1.6156	1.4185	1.5969	1.7933	2.0804	2.3421	2.6302	2.9088	3.2815	3.6926	4.1429	4.6736	5.2591
90	1.1322	1.2680	1.4165	1.2083	1.3667	1.5419	1.7722	2.0044	2.2615	2.4600	2.7887	3.1534	3.5036	3.9717	4.4912
95	0.9868	1.1096	1.2445	1.0334	1.1741	1.3308	1.5156	1.7221	1.9518	2.0883	2.3787	2.7026	2.9742	3.3878	3.8492
100	0.8627	0.9738	1.0965	0.8878	1.0132	1.1534	1.3021	1.4860	1.6917	1.7805	2.0375	2.3258	2.5358	2.9019	3.3125
105	0.7572	0.8580	0.9697	0.7655	0.8775	1.0032	1.1228	1.2870	1.4714	1.5235	1.7513	2.0082	2.1698	2.4943	2.8602
110	0.6665	0.7580	0.8600	0.6625	0.7626	0.8756	0.9717	1.1185	1.2842	1.3071	1.5093	1.7384	1.8616	2.1496	2.4759
115	0.5883	0.6715	0.7646	0.5753	0.6650	0.7666	0.8438	0.9753	1.1244	1.1259	1.3058	1.5106	1.6036	1.8598	2.1514
120	0.5206	0.5964	0.6815	0.5017	0.5822	0.6739	0.7359	0.8539	0.9884	0.9738	1.1341	1.3176	1.3869	1.6153	1.8765
125	0.4621	0.5311	0.6090	0.4390	0.5113	0.5942	0.6438	0.7500	0.8715	0.8441	0.9872	1.1517	1.2023	1.4060	1.6403

Temp. (°C)	NTH5G**P41B683J type			NTH5G**P42B104J type			NTH5G**P45A224J type			NTH5G**P45A474J type			NTH5G10P/16P33B103F type		
	Resistance (kΩ)			Resistance (kΩ)			Resistance (kΩ)			Resistance (kΩ)			Resistance (kΩ)		
	Low	Center	High	Low	Center	High	Low	Center	High	Low	Center	High	Low	Center	High
-40	2325.9631	2735.3593	3208.7719	3729.0380	4397.1193	5171.9295	9772.5429	11585.8840	13701.3597	20877.7053	24751.6612	29271.0867	188.0202	195.6520	203.5731
-35	1664.5604	1937.3907	2249.3020	2647.2336	3088.5989	3594.5428	6837.3274	8016.9727	9376.6420	14607.0177	17127.1689	20031.9170	142.7877	148.1710	153.7418
-30	1205.6590	1389.3445	1597.0123	1902.5755	2197.2250	2531.1628	4847.6927	5623.9311	6508.1538	10356.4343	12014.7619	13903.7832	109.5221	113.3471	117.2940
-25	883.2052	1008.0144	1147.5848	1383.3182	1581.8805	1804.4223	3474.9659	3990.1000	4570.1443	7423.7909	8524.3045	9763.4901	84.8227	87.5588	90.3741
-20	653.5386	738.9776	833.4974	1016.2022	1151.0367	1300.5024	2517.2944	2861.7839	3245.2829	5377.8563	6113.8111	6933.1044	66.2694	68.2367	70.2554
-15	488.5367	547.4555	611.9463	754.3293	846.5788	947.7345	1843.9098	2076.1619	2331.8235	3939.2618	4435.4368	4981.6229	52.2283	53.6496	55.1040
-10	368.7125	409.5999	453.8837	565.4664	628.9882	697.8966	1363.4416	1520.9094	1692.3223	2912.8070	3249.2156	3615.4158	41.4765	42.5062	43.5570
-5	280.7073	309.2166	339.7697	427.6799	471.6321	518.8009	1017.7304	1125.0494	1240.5760	2174.2421	2403.5146	2650.3214	33.1462	33.8922	34.6515
0	215.6355	235.6064	256.7833	326.4567	357.0117	389.4505	766.4841	839.9121	918.0736	1637.4887	1794.3578	1961.3390	26.6780	27.2186	27.7675
5	166.9555	180.9801	195.6923	251.2051	272.4995	294.8601	582.1552	632.5207	685.5255	1243.6953	1351.2943	1464.5318	21.6294	22.0211	22.4175
10	130.2753	140.1394	150.3734	194.8470	209.7098	225.1420	445.6263	480.1943	516.1503	952.0198	1025.8697	1102.6846	17.6430	17.9255	18.2107
15	102.4068	109.3437	116.4586	152.2795	162.6506	173.2936	343.7517	367.4554	391.8117	734.3785	785.0184	837.0523	14.4712	14.6735	14.8772
20	81.0612	85.9287	90.8607	119.8614	127.0802	134.3970	267.1098	283.3096	299.7408	570.6436	605.2524	640.3553	11.9371	12.0805	12.2244
25	64.6000	68.0000	71.4000	95.0000	100.0000	105.0000	209.0000	220.0000	231.0000	446.5000	470.0000	493.5000	9.9000	10.0000	10.1000
30	51.1085	54.1668	57.2645	74.7365	79.2216	83.7660	162.2097	172.0121	181.9509	346.5388	367.4804	388.7133	8.2162	8.3145	8.4132
35	40.6980	43.4205	46.2092	59.1874	63.1671	67.2459	126.7354	135.3636	144.2178	270.7529	289.1859	308.1016	6.8534	6.9479	7.0430
40	32.6091	35.0157	37.5059	47.1711	50.6766	54.3066	99.6651	107.1980	115.0120	212.9209	229.0139	245.7074	5.7443	5.8336	5.9238
45	26.2879	28.4056	30.6173	37.8301	40.9035	44.1161	78.8770	85.4186	92.2716	168.5099	182.4853	197.1257	4.8333	4.9169	5.0015
50	21.3078	23.1657	25.1226	30.5087	33.1946	36.0267	62.7810	68.4412	74.4252	134.1230	146.2153	158.9993	4.0833	4.1609	4.2395
55	17.3695	18.9967	20.7244	24.7475	27.0909	29.5820	50.2655	55.1533	60.3652	107.3854	117.8276	128.9620	3.4634	3.5350	3.6076
60	14.2330	15.6569	17.1803	20.1817	22.2243	24.4126	40.4494	44.6645	49.1955	86.4147	95.4197	105.0996	2.9486	3.0143	3.0812
65	11.7211	12.9669	14.3092	16.5424	18.3225	20.2434	32.7434	36.3787	40.3166	69.9518	77.7182	86.1309	2.5259	2.5861	2.6476
70	9.7029	10.7935	11.9765	13.6319	15.1841	16.8709	26.6276	29.7626	33.1836	56.8863	63.5838	70.8922	2.1724	2.2275	2.2839
75	8.0657	9.0206	10.0634	11.2813	12.6354	14.1166	21.7572	24.4623	27.4350	46.4814	52.2604	58.6111	1.8741	1.9245	1.9761
80	6.7376	7.5749	8.4949	9.3830	10.5657	11.8678	17.8683	20.2054	22.7911	38.1732	43.1662	48.6902	1.6225	1.6685	1.7157
85	5.6522	6.3872	7.1997	7.8382	8.8726	10.0184	14.7397								



**⚠ Note:****1. Export Control**

〈For customers outside Japan〉

Murata products should not be used or sold for use in the development, production, stockpiling or utilization of any conventional weapons or mass-destructive weapons (nuclear weapons, chemical or biological weapons, or missiles), or any other weapons.

〈For customers in Japan〉

For products which are controlled items subject to the "Foreign Exchange and Foreign Trade Law" of Japan, the export license specified by the law is required for export.

**2. Please contact our sales representatives or product engineers before using our products listed in this catalog for the applications listed below which require especially high reliability for the prevention of defects which might directly cause damage to the third party's life, body or property, or when intending to use one of our products for other applications than specified in this catalog.**

- ① Aircraft equipment
- ② Aerospace equipment
- ③ Undersea equipment
- ④ Power plant equipment
- ⑤ Medical equipment
- ⑥ Transportation equipment (vehicles, trains, ships, etc.)
- ⑦ Traffic signal equipment
- ⑧ Disaster prevention / crime prevention equipment
- ⑨ Data-processing equipment
- ⑩ Application of similar complexity and/or reliability requirements to the applications listed in the above

**3. Product specifications in this catalog are as of December 1999. They are subject to change or our products in it may be discontinued without advance notice.**

Please check with our sales representatives or product engineers before your ordering. If there are any questions, please contact our sales representatives or product engineers.

**4. The parts numbers and specifications listed in this catalog are for information only. You are requested to approve our product specification or to transact the approval sheet for product specification, before your ordering.****5. Please note that unless otherwise specified, we shall assume no responsibility whatsoever for any conflict or dispute that may occur in connection with the effect of our and/or third party's intellectual property rights and other related rights in consideration of your using our products and/or information described or contained in our catalogs. In this connection, no representation shall be made to the effect that any third parties are authorized to use the rights mentioned above under licenses without our consent.****6. None of ozone depleting substances (ODS) under the Montreal Protocol is used in manufacturing process of us.**